

Holding Capacity	Structure Weight	Concrete
71.98 Gals./V.FT	Bot. Slab= 1560 LBS. Wall = 920 LBS./V.FT. TOP SLAB 1240	4,000 PSI @ 28 Days

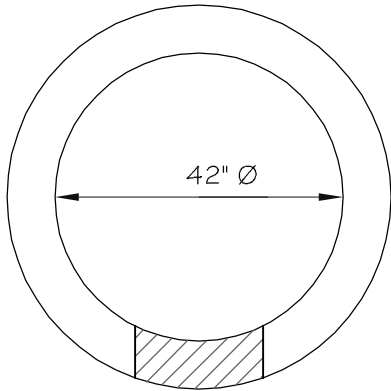

Hole Opening Varies

WALL PLAN VIEW

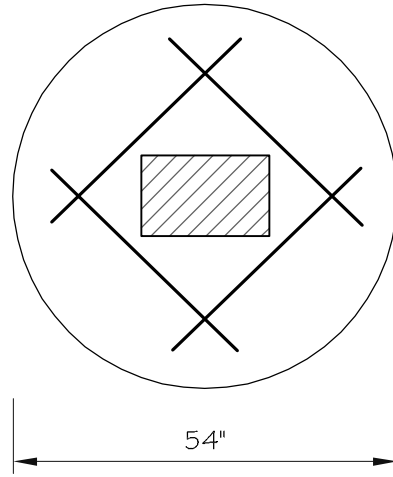

TOP SLAB PLAN VIEW

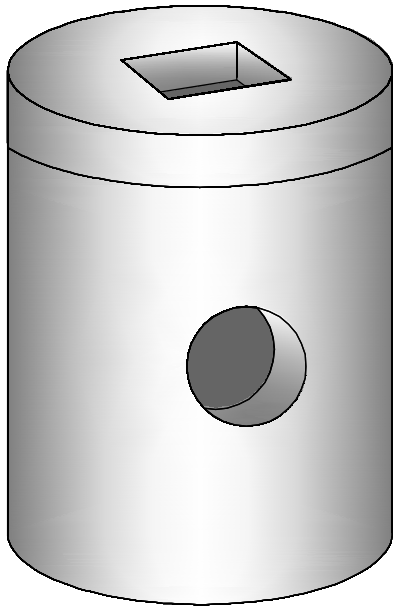

3 DIMENSIONAL VIEW

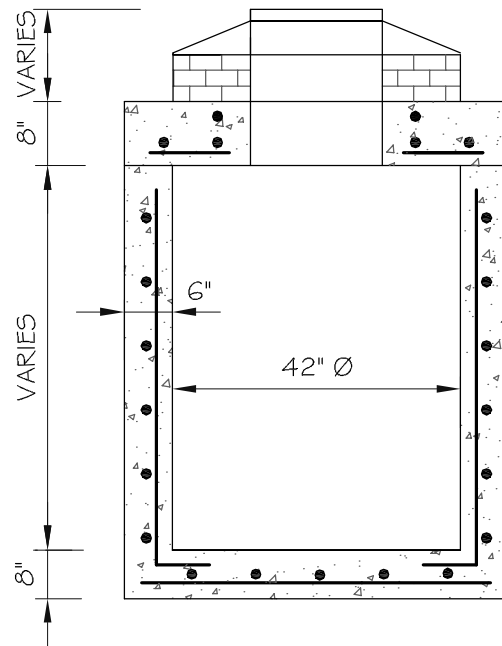

SECTION VIEW



CATCH BASIN TYPE D-42 Ø

www.precastdepot.com

11002 NW South River Drive
 Medley, Florida 33178
 Phone: 305-259-5956
 Fax: 305-885-2534