

Holding Capacity	Structure Weight	Concrete
52.82 Gals./V.FT	Bot. Slab= 930 LBS. Wall = 800 LBS./V.FT. TOP SLAB 960 LBS	4,000 PSI @ 28 DAYS

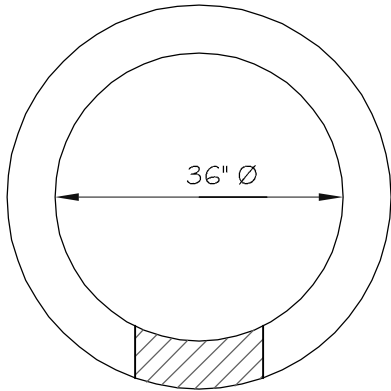

Hole Opening Varies

WALL PLAN VIEW

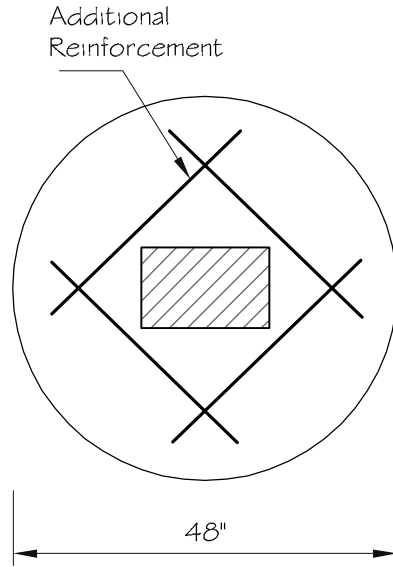

TOP SLAB PLAN VIEW

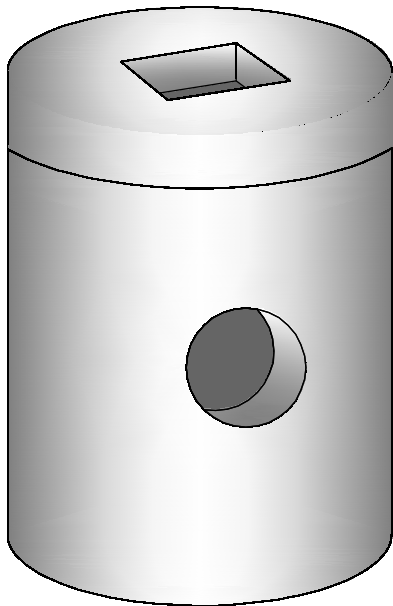

3 DIMENSIONAL VIEW

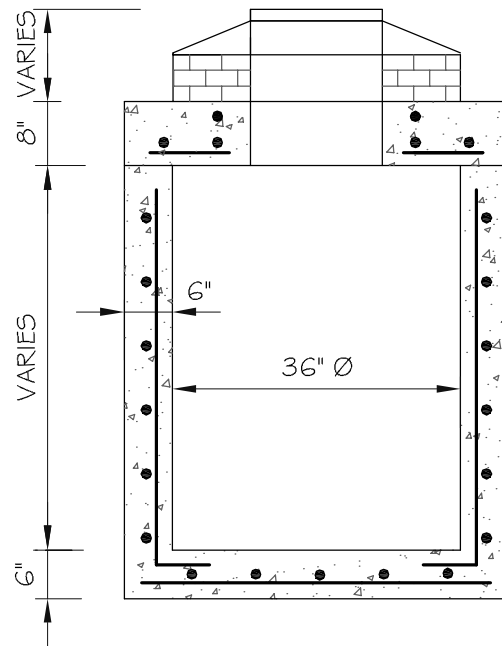

SECTION VIEW



CATCH BASIN TYPE D-3 Ø

www.precastdepot.com

11002 NW South River Drive
 Medley, Florida 33178
 Phone: 305-259-5956
 Fax: 305-885-2534